

Design of Braille cell Setting Actuators for the Application in the Braille Mouse Concept

Tiene Nobels*, Frank Allemeersch** and Kay Hameyer***

Abstract - Refreshable Braille displays have already been developed in the past, but they remain quite bulky and expensive. Small displays contain only a single or a few Braille cells, with pins pushing into the fingertips. However, they are not as successful as larger displays because the skin is more sensitive to lateral movement than to orthogonal pressure. This paper presents the design of linear electromagnetic actuators, which allows a considerable reduction in size and cost for such refreshable Braille displays. Different actuator concepts are compared. A new actuator is proposed and optimised by means of finite element simulations, which are verified with measurements on a prototype.

Keywords: Electromagnetic Design, Linear Actuators, Simulation, and Permanent Magnet Motors.

1. Introduction: refreshable Braille

Existing refreshable Braille displays Fig. 1 consist of 20 to 80 Braille cells allowing one line of text to be shown at a time (e.g. [1], [2]). For reading, fingertips slide over the pins of the Braille cells, just as with "paper Braille".

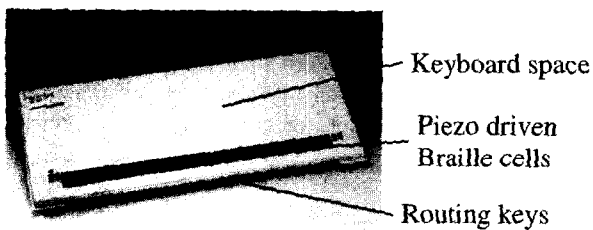

Fig. 1 Commercial refreshable Braille display [1].

The Braille alphabet, used by blind people all over the world, is a tactile representation of the Roman alphabet. As an example, the sentence 'hello world' is given in Fig. 2. The objective of this study is to develop a portable and inexpensive refreshable Braille display to further disclose computer use to visually impaired persons.

Fig. 3 shows the Braille cell used in this paper, which consists of 8 pins in a 2 by 4 matrix, allowing eight-dot computer Braille (the lowest row contains status pins). Each pin has two stable equilibrium positions, a *set* or *up* position and a *reset* or *down* position.

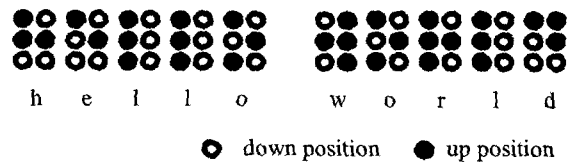

Fig. 2 The Braille alphabet: example.

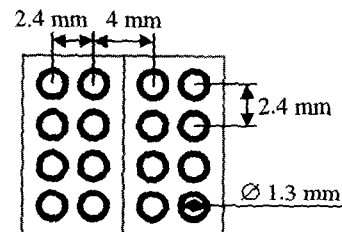

Fig. 3 Dimensions of a computer Braille cell.

2. Design concept of the Braille mouse

Small displays containing only a single Braille cell are not able to realize the sensation of movement. In [3] has been shown that movement brings a major contribution to the sense of touch.

The sensation of moving over a line of Braille characters without the need of a bulky linear display can be achieved with a rotating ring [4], [5]. A ring on which Braille cells are located rotates inside a housing Fig. 4. Only a part of the ring can be read in a window ('3 character display'), the housing covers the remainder. The rotating ring concept permits infinite text lines and an increased reading speed because the hand has not to return to the beginning of the line [5].

The pin position of the Braille cells that are covered by the housing is unimportant. As the ring rotates, a new cell

* Dept. of Electrical Engineering, Katholieke Universiteit Leuven, Belgium. (Tiene.Nobels@esat.kuleuven.ac.be)

** Sensotec NV, Belgium. (Frank.Allemeersch@sensotec.be)

*** Dept. of Electrical Machines, Aachen University (RWTH), Germany. (Kay.Hameyer@iem.rwth-aachen.de)

enters the window in the housing. Just before this point, the pins have to be set: each pin takes a predetermined position according to a particular letter of the Braille alphabet Fig. 2. Once a Braille cell is located in the window, pins should retain their position. After leaving the window, pins can be reset.

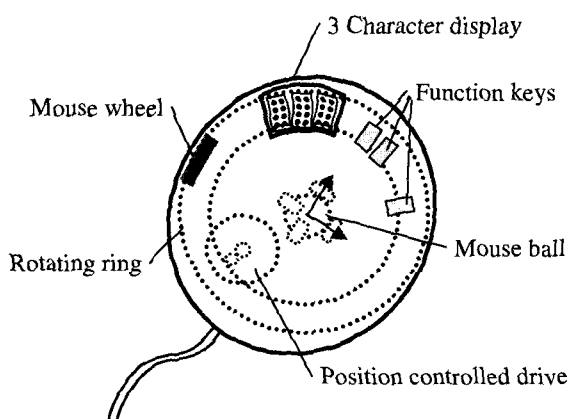

Fig. 4 Design concept of a Braille mouse.

This design concept permits to split up functions: if the pins are bi-stable, the actuation of the pins can be done remotely, i.e. under the housing. For this activation, fewer actuators are required in comparison with classic Braille displays: four setting actuators are sufficient whereas about 600 actuators are required for a regular large linear display.

2.1 Creating Stable Positions

Permanent magnets (PM) provide a promising way to obtain bistable positions. A ferromagnetic needle is thread through a standard PM ring in order to build a so-called reading pin. The rotating ring is composed of two perforated annular ferromagnetic plates holding 320 of those reading pins (Fig. 5) in vertical position. A reading pin is locked in the up (resp. down) position because of the magnetic flux lines closing through the upper (resp. lower) plate. The perforations are designed in order to optimise the holding forces [6].

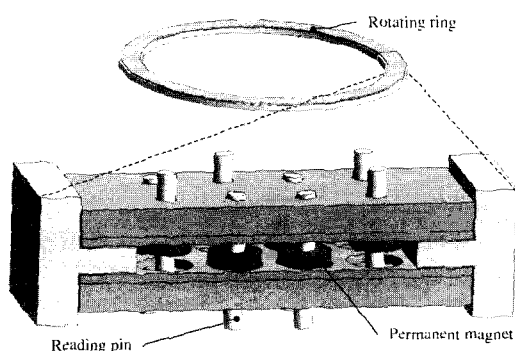

Fig. 5 Permanent magnet bistable pins in a ferromagnetic rotating ring.

The main drawback of the magnetic holding concept is therefore the rather complex shape of the perforated plates. A simpler geometry is possible if the pins are mechanically blocked when located in the reading window. In this case however, friction becomes a significant problem. Moreover the setting of the pins should happen just before they enter the reading window, whereas the magnetic concept allows a less strict timing.

2.2 Setting of Reading Pins: Concepts

In the Braille mouse concept presented here, the Braille pins should only have their fixed position in the reading window. An actuator has to set the pins in their predetermined position before they enter the reading area. For this purpose one actuator for each circle of pins is required Fig. 6.

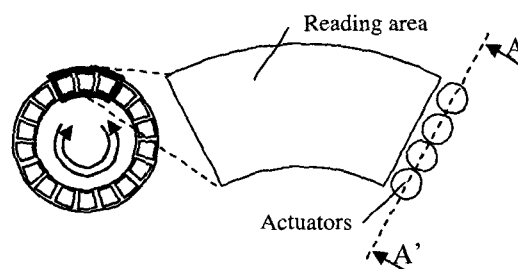

Fig. 6 Position of setting actuators.

3. Direct Activation

Activating the reading pins with as few moving parts as possible is a very attractive option from the mechanical point of view. The stator of a direct actuator is fixed to the housing; the plunger of the actuator is the reading pin itself.

In an electromagnetic actuator power is transmitted from the stator to the plunger by the magnetic field. By controlling this magnetic field, the transferred power and thus the force on the pin are controlled. Different principles can be applied to exert this force.

3.1 Reluctance force

The first concept is based on reluctance forces, as shown in Fig. 7a. The stator consists of two coils wound round an E-shaped ferromagnetic core. The ferromagnetic pin and the E-shaped core make up the magnetic path. If the upper (respectively lower) coil is activated, the pin switches up (respectively down).

The force exerted on the pin depends on the magnetic field distribution. As the pin itself is part of the magnetic path, the field distribution and the force are a function of the position of the pin.

Fig. 7 shows two variants of this concept. Model II not only causes a different flux distribution, but also provides a mechanical stop for the pins.

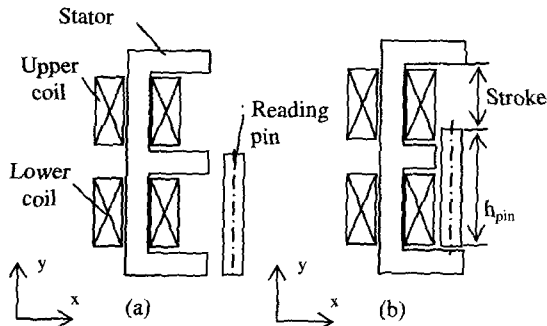

Fig. 7 Actuator based on reluctance forces. Model I (a) and model II (b).

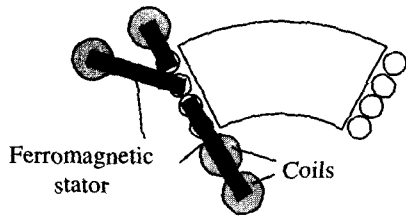

Fig. 8 Examples of positioning of the actuators around the ring.

When applying this type of actuator in the rotating ring concept, the construction of the actuator becomes more complex as the actuators need to set pins on four concentric circles. Fig. 8 indicates possible solutions for this positioning problem. The ferromagnetic core will unavoidably be larger. Also the ring that holds the reading pins is part of the returning flux path for all four actuators.

3.2 Permanent magnets

The second concept involves permanent magnet material. A cup-shaped magnetic core with a coil Fig. 9 plays the role of a switchable electromagnet. According to the sign of the current in the coil it can attract or repel the permanent magnet (PM) fixed to the reading pin.

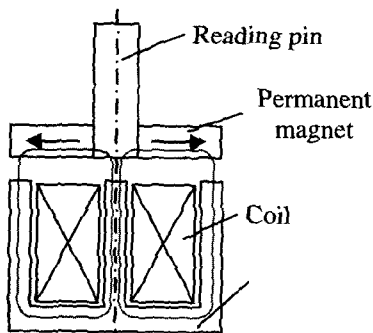

Fig. 9 Actuator with permanent magnet on the reading pin.

If the PM is attached to the reading pin Fig. 9, the construction and positioning of the actuators is less complicated than in the previous case. With a PM at the bottom of each reading pin, the actuating coils can be positioned under the rotating ring, whereas for the reluctance principle the actuators have to be positioned above and under the ring.

4. Indirect activation

In the second group of actuators the reading pins are mechanically actuated by means of a plunger. The latter is an extra moving part. On the other hand, the actuator diameter can be larger and positioned further away from the reading pin as levers can be used. The main drawback of those actuators is their unidirectional character: they can only push. All reading pins have thus to be pulled down before entering the activation area. This clearing can be achieved either magnetically or mechanically Fig. 10. A magnetic clearing principle consists of a permanent magnet pulling at ferromagnetic pin bottoms. Another possibility is a slope in the housing to push the pins down, but this involves more friction and wear on the pin tops.

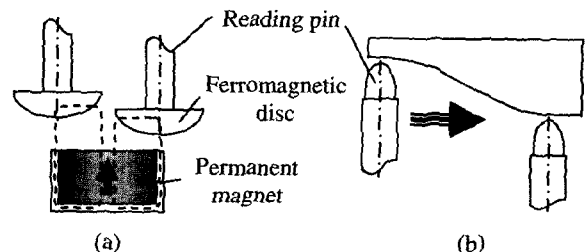

Fig. 10 Clearing mechanisms for the reading pins. Magnetic principle (a) and mechanical principle (b).

4.1 Activation with piezobenders

Present refreshable Braille cells are composed of eight bimorph piezo bending elements Fig. 11, which deliver holding forces of 0.1 N and static displacements of 1 mm.



Fig. 11 State of the art Braille cell, based on piezo technology.

If their speed is high enough, they are capable of launching the reading pins into the mechanical fixation block. A typical resonance frequency of bending piezo elements is 100 Hz [8], [9], which means that it takes 10 ms to change from one position to the other. For low speed-reading, these actuators can fulfil the requirements.

4.2 Electromagnetic activation: solenoids

If a current is applied to the coil of Fig. 12, the ferromagnetic plunger will move up, raising the reading pin. If the gravity is not sufficient, a spring is required to drop the plunger back to its ‘low’ position.

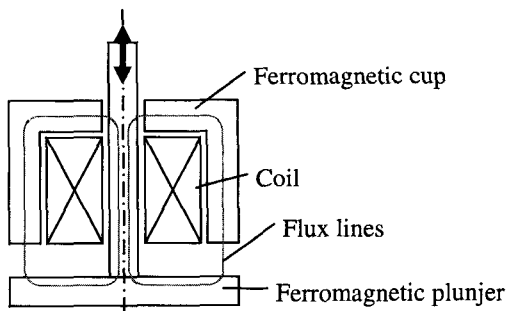

Fig. 12 Solenoid in a ferromagnetic cup.

A ferromagnetic cup round the coil acts as a flux concentrator. As the force is proportional to the square of the flux density, the exerted force is improved.

Nevertheless the air gap force density is limited by the current density in the coil. The diameter of the solenoid is restricted to 2.4 mm. Therefore in order to attain high currents to generate high forces the solenoid has to be relatively high.

4.3 Electromagnetic activation: the 4-in-1 actuator

In order to overcome the disadvantages of solenoids we propose to apply the principle of a small linear motor. In this motor the actuators for all four circles are combined in one entity. The moving parts are four planar coils on which Lorentz forces act, eq. (1).

$$d\vec{F} = n\vec{I} \cdot d\vec{l} \times \vec{B} \tag{1}$$

The magnetic field \vec{B} is excited by permanent magnets, arranged between the coils. Fig. 13 shows a first concept.

As the coils are placed vertically instead of horizontally their diameter is not restricted any more by the distance between two reading pins. On the other hand, the distance between two Braille pins limits their width.

Printed Circuit Board techniques can be used to create planar coils within the height limit. Standard four-layer PCB's are 1.7 mm thick 00. As permanent magnets, which

are thinner than 0.6 mm, are hard to find on the market, the actuator design had to be adapted. Another adjustment involves the returning flux path. This flux could be exploited according to Fig. 14.

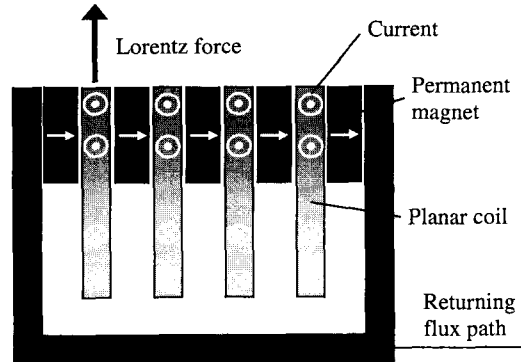

Fig. 13 Principle of 4-in-1 actuator.

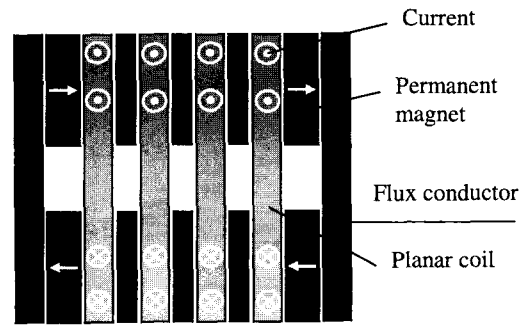

Fig. 14 Design of the 4-in-1 actuator.

5. Setting of the reading pins: specifications

5.1 Available time for activation of each pin

The concept of the rotating ring permits to minimize the number of actuators for the setting of the reading pins. Design specifications for those actuators no longer depend on the holding forces, as those are important only in the reading area. On the other hand, those actuators have to fulfil strong speed specifications.

Fig. 3 shows that the minimum distance between two Braille pins is only 2.4 mm. Because of the circular shape of the ring, this distance is better defined as an angle Fig. 15.

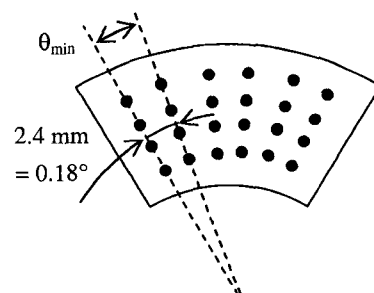

Fig. 15 Position of the pins on the ring.

The time during which a pin can be set is a function of this angle but also of the influence width d_a of the actuator. Fig. 16 explains this for indirect activation. Let us consider the situation in which pin A should be high whereas the previous pin is low. Before activation all pins are low. Pin B stays low, as does the actuator. Activation of pin A cannot start before this pin has moved away far enough from the actuator. The time available for activation of pin A is the time while the width of the pin plus the air gaps on both sides is above the actuator head. Before the next pin enters this area, however, the actuator should have returned to its original state in order to avoid a collision with the next pin.

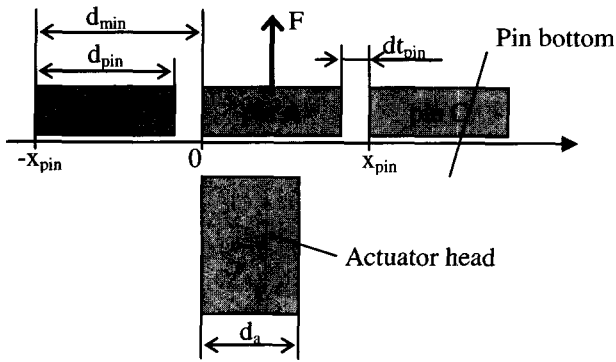

Fig. 16 Position of pins and activation.

The available time is inversely proportional to the speed ω_{ring} of the rotating ring. This speed is related to the maximum Braille reading speed, which is about 15 characters per second [7].

Keeping this in mind the available time Δt can be expressed as follows:

$$\Delta t = \frac{d_{min} + dt_{pin} - d_a}{v_{ring}} = \frac{\theta_{min} + \beta_{pin} - \theta_a}{\omega_{ring}} \quad (2)$$

The available activating time Δt for a reading speed of 15 characters per second [7] and, for example an equal width of 2.0 mm for the pin and actuator, results in 8.3 ms.

5.2 Activation time for actuators

For each type of actuator the time required for a whole cycle (moving up and down) can be derived from force calculations through the law of Newton. As the force is a function of the position, the acceleration is not constant. Therefore, the motion equation (3) can only be used as an approximation over short distances, eq. (4).

$$z = \frac{a}{2}(t - t_0)^2 + v_0 \cdot (t - t_0) + z_0 \quad (3)$$

$$z[k] = \frac{a[k]}{2} dt[k]^2 + v[k] \cdot dt[k] + z[k-1] \quad (4)$$

$$\text{with } v[k] = a[k-1] \cdot dt[k-1] + v[k-1]$$

$$F[k] = m \cdot a[k]$$

The total time t , eq. (5), the actuator requires to move from the lowest to the highest position has to be within the available activating time Δt , eq. (2).

$$t = \sum_k dt[k] \quad (5)$$

Some actuator principles are simulated in order to compare forces and setting times of two direct and two indirect electromagnetic actuator concepts.

6. Direct activation: Calculations

6.1 Reluctance force

The electromagnetic field distribution is calculated for the geometry of Fig. 7b with the finite element method. A two-dimensional model enables the force computation for several reading pin lengths (h_{pin}) as a function of the position of the pin and the current in the coils.

Fig. 17 shows the force acting on the pin as a function of the position of the plunger. Parameter is the current in the upper coil. With larger currents, the force grows parabolic.

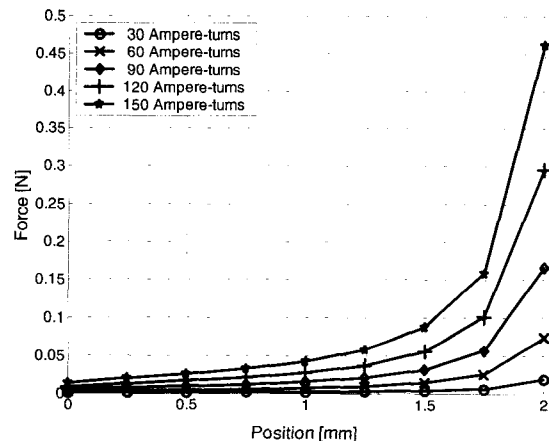

Fig. 17 Calculated force for the reluctance principle. The coil section equals 6 mm^2 .

The results of transient calculations are shown in Fig. 18. The time is plotted as a function of the current density in the upper coil. The parameter in this figure is the displacement distance that is the complement of the height of the pin Fig. 7. As the reluctance forces depend on the length of the pin, displacement times are shorter for longer

pins. However, the switching times are too large to be useful for the Braille mouse application.

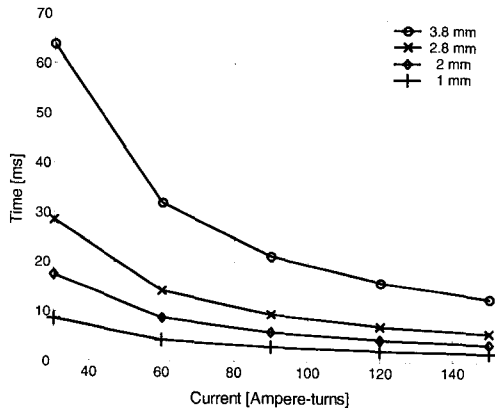

Fig. 18 Time needed for the displacement from the low to the high position. Parameter is the stroke of the actuator.

6.2 Permanent magnets

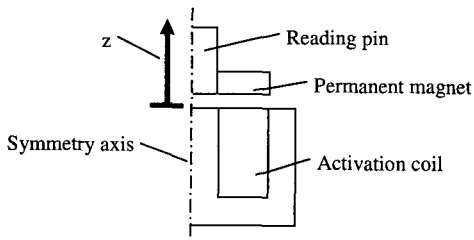

Fig. 19 Model of direct PM actuator.

The activating coil and the permanent magnet are calculated with an axisymmetric model Fig. 19. The simulations indicated that the permanent magnet should be rather weak in order to limit the current density. Fig. 20 shows the pushing force on a magnet as a function of its position with the current density in the coil as parameter. For this magnet current densities of at least 10 A/mm² are necessary to obtain upward forces.

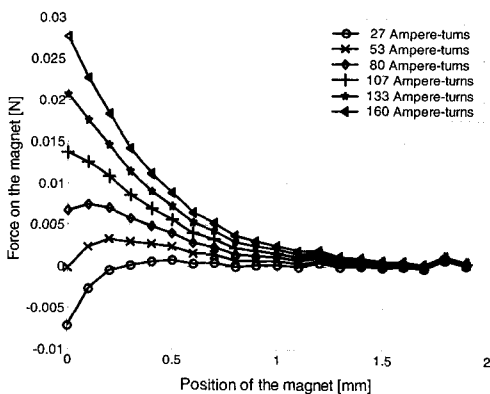

Fig. 20 Force acting on the magnet as a function of the vertical displacement of the magnet. $H_c = 200$ kA/m; $h_{coil} = 10$ mm; copper section = 6 mm².

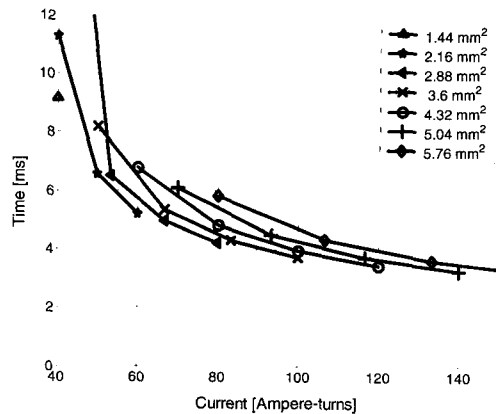

Fig. 21 Time required for an upward displacement of 1 mm. The parameter is the coil section.

The time to raise the pin by 2 mm is derived from the force calculations. Fig. 21 demonstrates activation is possible in less than 10 ms, but high current densities are required.

7. Indirect activation: Calculations

7.1 Electromagnetic activation: solenoids

The disadvantage of solenoids is their limited force density (Fig. 22). Larger forces would only be possible for higher currents, but – as current density has to be limited because of temperature rise - the solenoid would have to be quite large in this case. Moreover, saturation problems limit the force as well.

However, the Braille mouse application requires a small diameter actuator (less than 2.4 mm) as well as a limited height for it. This implies solenoids cannot be used together with a mechanical blocking mechanism as mentioned before.

When distances between activation points can be larger, as in the case of a magnetic fixation, standard solenoids can be the most economical solution. Fig. 23 shows that the necessary time for a displacement of 2 mm decreases with increasing diameter of the solenoid.

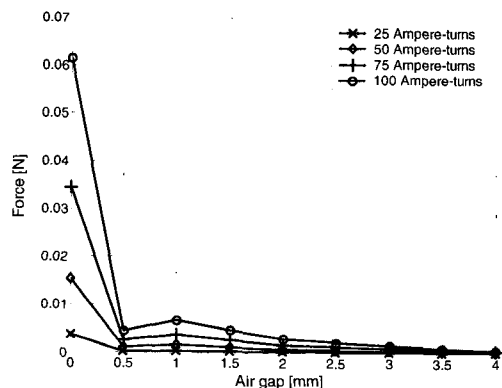

Fig. 22 Force on the solenoid of Fig. 12. Diameter of the solenoid is 2.4 mm. Parameter is the current density.

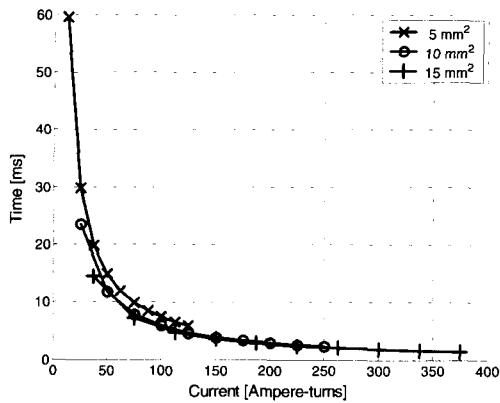

Fig. 23 Time required for an upward displacement of 2 mm. The parameter is the coil section.

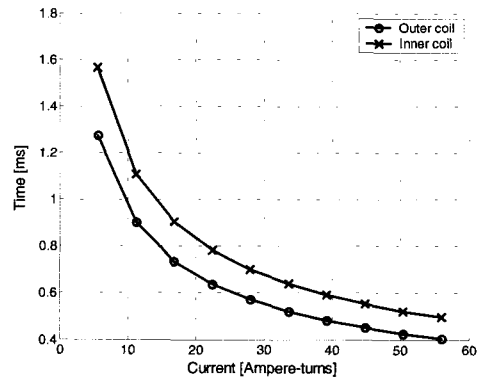

Fig. 26 Time needed for a displacement of 2 mm as a function of the current through the coils.

7.2 Electromagnetic activation: the 4-in-1 actuator

Fig. 24 shows a simplified 2D model of the 4-in-1 actuator and the calculated flux lines. Leakage lowers significantly the flux through the middle coils. Simulations show that the flux through the inner coils is only 60 % of the flux through the outer coils. As a consequence also the force acting on the inner coils is lower than the force on the outer coils. Saturation has a negligible influence on the flux distribution that causes the force to vary linearly with the current through the coils.

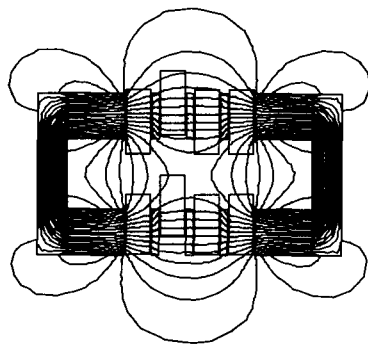

Fig. 24 Flux lines 4-in-1 actuator

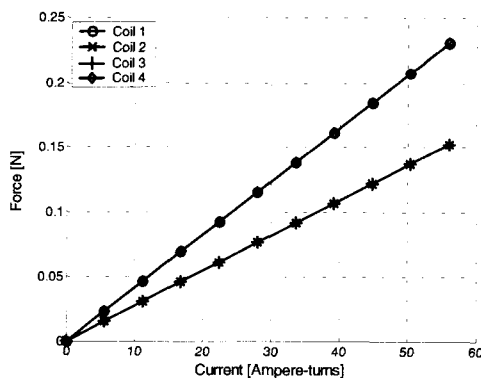

Fig. 25 Force on each coil as a function of the current through the coil. Coil 1 and coil 4 are the outer coils, coil 2 and coil 3 the inner coils.

8. Prototype

A prototype of the 4-in-1 actuator is build. The coils are fabricated through standard Printed Circuit Board technology. Each coil has 54 windings with a copper section of 0.5 mm². Tracks with a width of 10 mil (0.25 mm) can carry a steady-state maximum current of 0.75 A in order to limit the temperature rise and a possible damage of the windings [10].

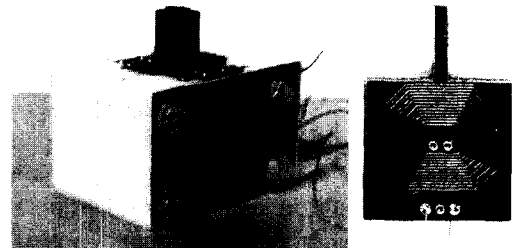

Fig. 27 Prototype of the 4-in-1 actuator.

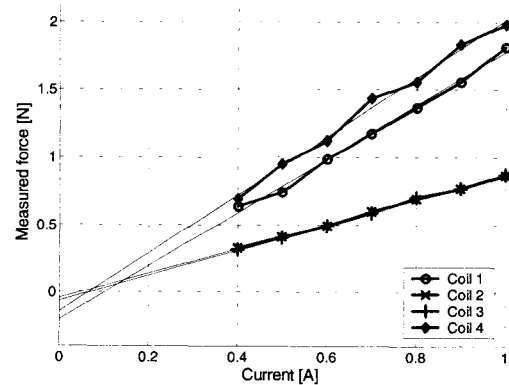

Fig. 28 Measured force as a function of the applied current for all four coils.

Force measurements on this prototype are presented in Fig. 28. The measured upward force of each coil is plotted

as a function of the current through the coil. The graph confirms the simulations.

9. Conclusion

Direct activation principles have often problems with achievable forces and force densities.

Direct activation is preferable from mechanical point of view. However, in spite of a simple setting actuator, the construction of the complete rotating ring concept can become rather complicated. Indirect activation has the disadvantage of a higher number of moving parts, but the overall design stays within complexity limits.

The most important aspects however are the speed requirements for the actuators. It has been shown that the linear motor has the shortest displacement time.

The developed 4-in-1 actuator combines a simple design of the rotating ring concept with optimal speed characteristics.

References

- [1] <http://www.papenmeier.de/reha/products/el80e.htm>, *Reha Braille* Displays, last visited on 18 April 2003.
- [2] <http://www.alva-bv.nl/>, *Alva Braille displays*, last visited on 26 March 2003.
- [3] M.M. Taylor, S.J. Lederman, *Tactile roughness of grooved surfaces: A model and the effect of friction*, *Perception & Psychophysics*, 1975, 17(1), pp. 23-26
- [4] S.J. Lederman, *The perception of surface roughness by active and passive touch*, *Bulletin of the Psychonomic Society*, 1981, 18(5), pp. 253-255
- [5] J. Roberts, O. Slattery, D. Kardos, *Rotating-Wheel Braille Display for Continuous Refreshable Braille*, Society for Information Display '00 conference in Long Beach, California, May 2000, Vol. XXXI, pp. 1130-1133
- [6] T. Nobels, F. Allemeersch, K. Hameyer, *Design of a high power density electromagnetic actuator for a portable Braille display*, EPE-PEMC, Dubrovnik, 2002
- [7] G.E. Legge, C. Madison, J.S. Mansfield, *Measuring Braille Reading Speed with the MNREAD test*, Visual impairment research, Minnesota, 2000
- [8] http://www.americanpiezo.com/products_services/stripe_actuators/performance.html, *piezo-actuators*, last visited on 18 February 2003.
- [9] G. Belforte, M.Sorli, L.Gastaldi, *Properties and mechanical performances of PZT actuators*, ACTUATOR 1998, Bremen
- [10] H. W. Johnson, M. Graham, *High-speed digital design: a handbook of black magic*, 1993, Prentice-Hall Englewood Cliffs (N.J.), pp214-220
- [11] <http://www.eurocircuits.com/Du/boardspec.cfm>, Printed Circuit Boards, last visited on 27 March 2003.



Tiene Nobels

She received the M.S degree in electrical engineering from the Katholieke Universiteit Leuven in 1999, where she is currently working as a research assistant and pursuing the PhD. degree on the subject of linear actuators for Braille applications. She also teaches electrical energy-technology at Groep T – Institute of Technology. Her research interests are linear actuators and electromagnetic design.

Frank Allemeersch

He received the Electrical Engineering degree in 1979 from the KIH Ostend, Belgium. After working a few years as development engineer for the Spermalie Institute, an institute for the education and support of people with a visual impairment, he was at the start-up of the company Sensotec nv in 1986. Sensotec nv is manufacturer of assistive devices for people with a print impairment and is the market leader in Belgium. As director of Sensotec nv he was involved in research projects, on European level as well as on local level.



Kay Hameyer

He received the M.Sc. degree in electrical engineering from the University of Hannover, Germany. He received the Ph.D. degree from University of Technology Berlin, Germany. After his university studies he worked with the Robert Bosch GmbH in Stuttgart, Germany. From 1996 to 2004 he was professor with the KULeuven Belgium. Currently he is full professor, director of the Electrical Machines Department and holds the chair for Electromagnetic Energy Conversion at the Aachen University (RWTH), Germany. Dr. Hameyer is an elected member of the board of the International Compumag Society, a senior member of the IEEE and a Fellow of the IEE.